

COMMITTENTE:	CASA DI RIPOSO SAN DOMENICO
PROGETTO:	PROGETTO DI SISTEMAZIONE DELLE AREE ESTERNE DELLA CASA DI RIPOSO SAN DOMENICO
PROGETTO:	1/200/100
DATA:	11/2011
PROFESSIONISTA:	PAOLINA SEZIONI SOVRAPPOSTE
PROFESSIONISTA:	5/1/00028
PROFESSIONISTA:	COCCOLI
PROFESSIONISTA:	TOZZOTTI

2

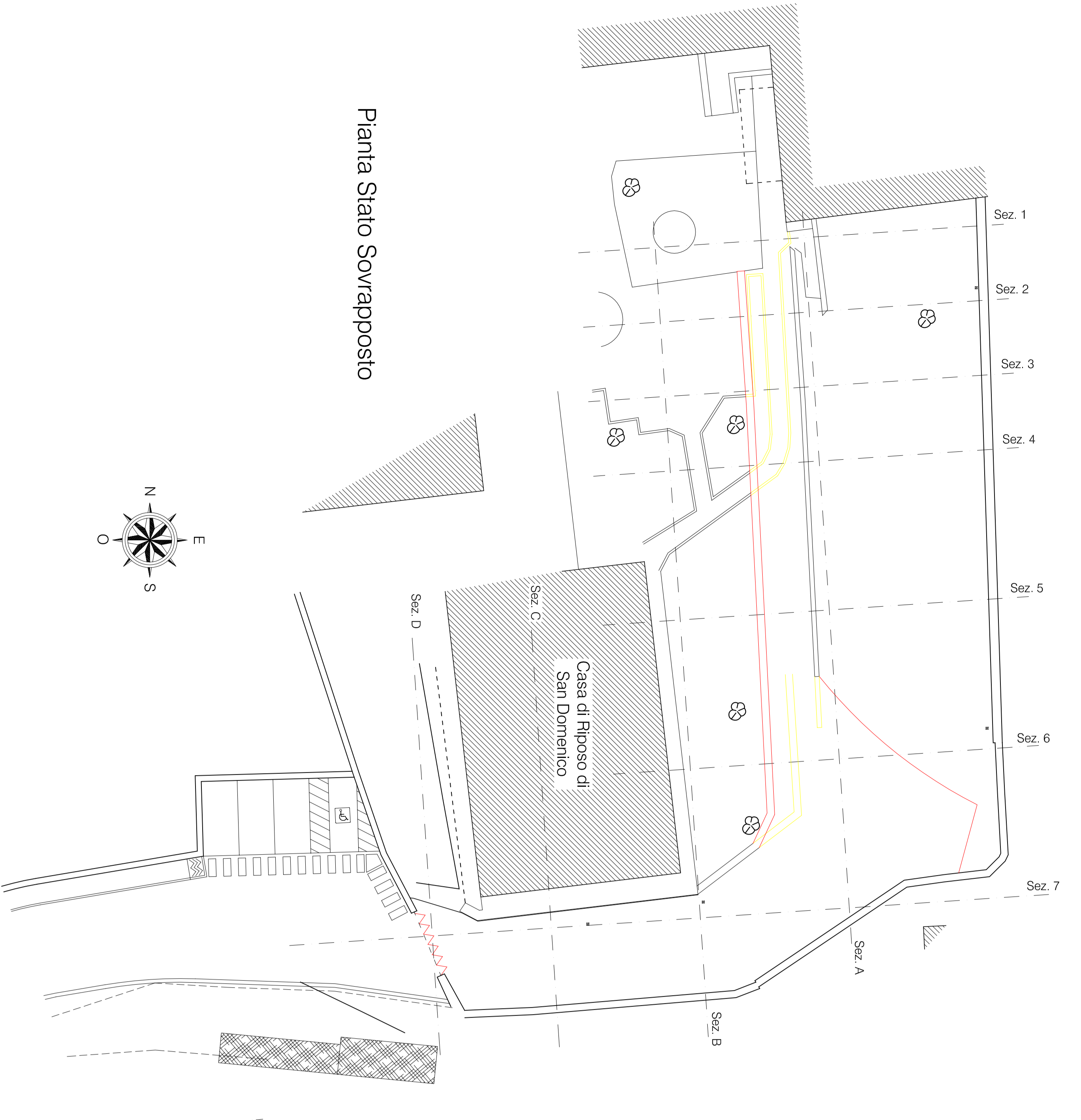

Pianta Stato Sovraposto

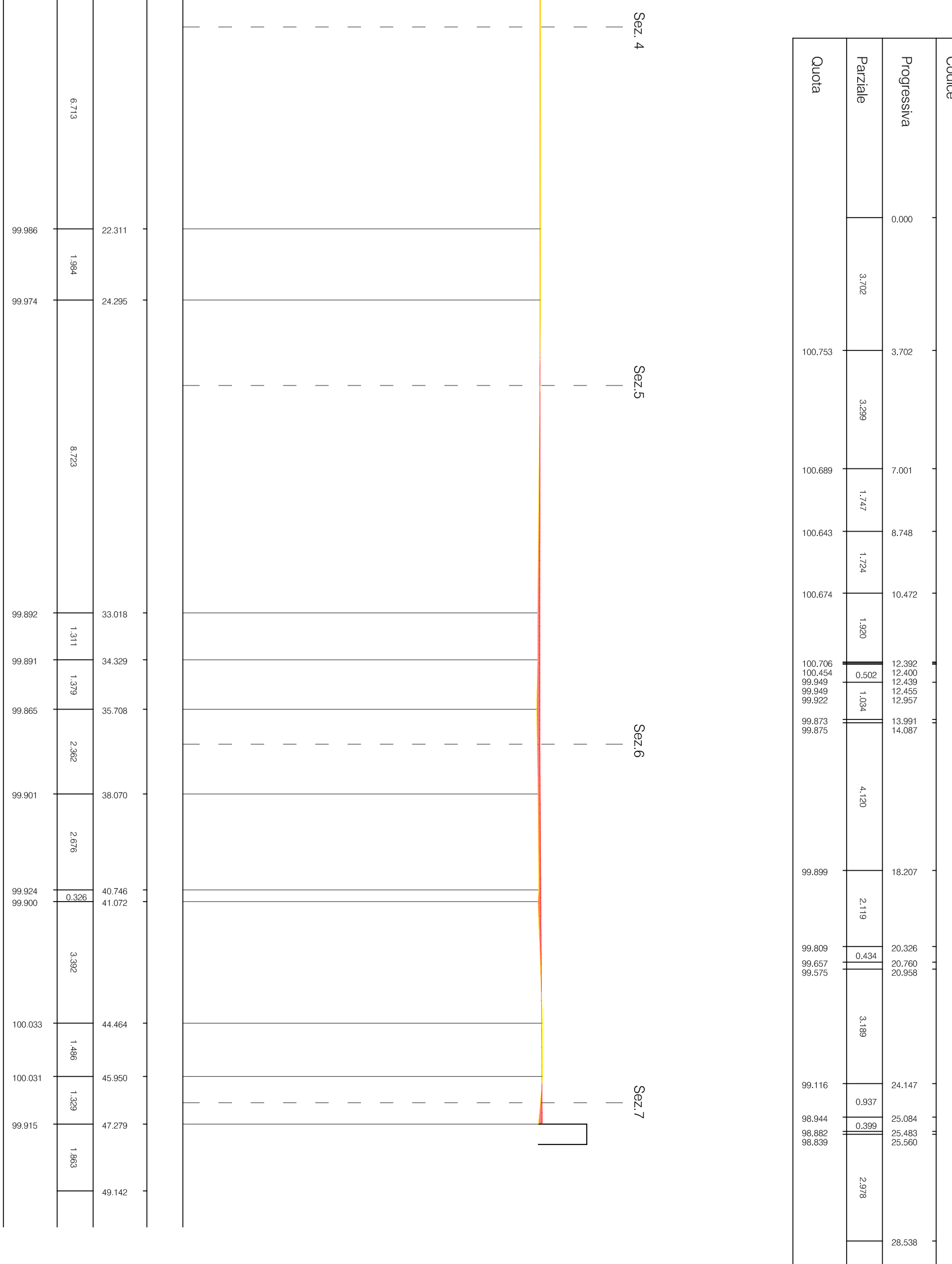
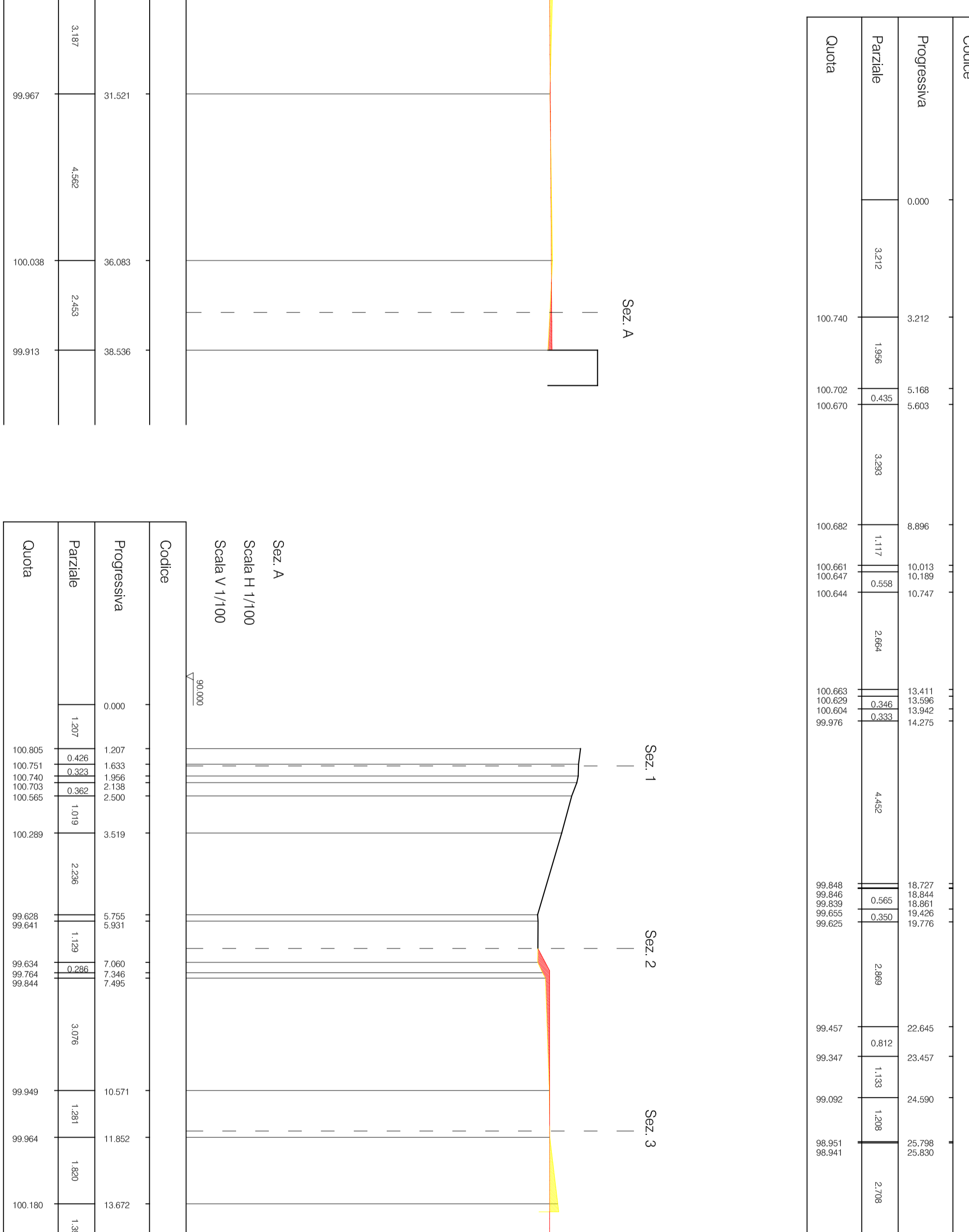
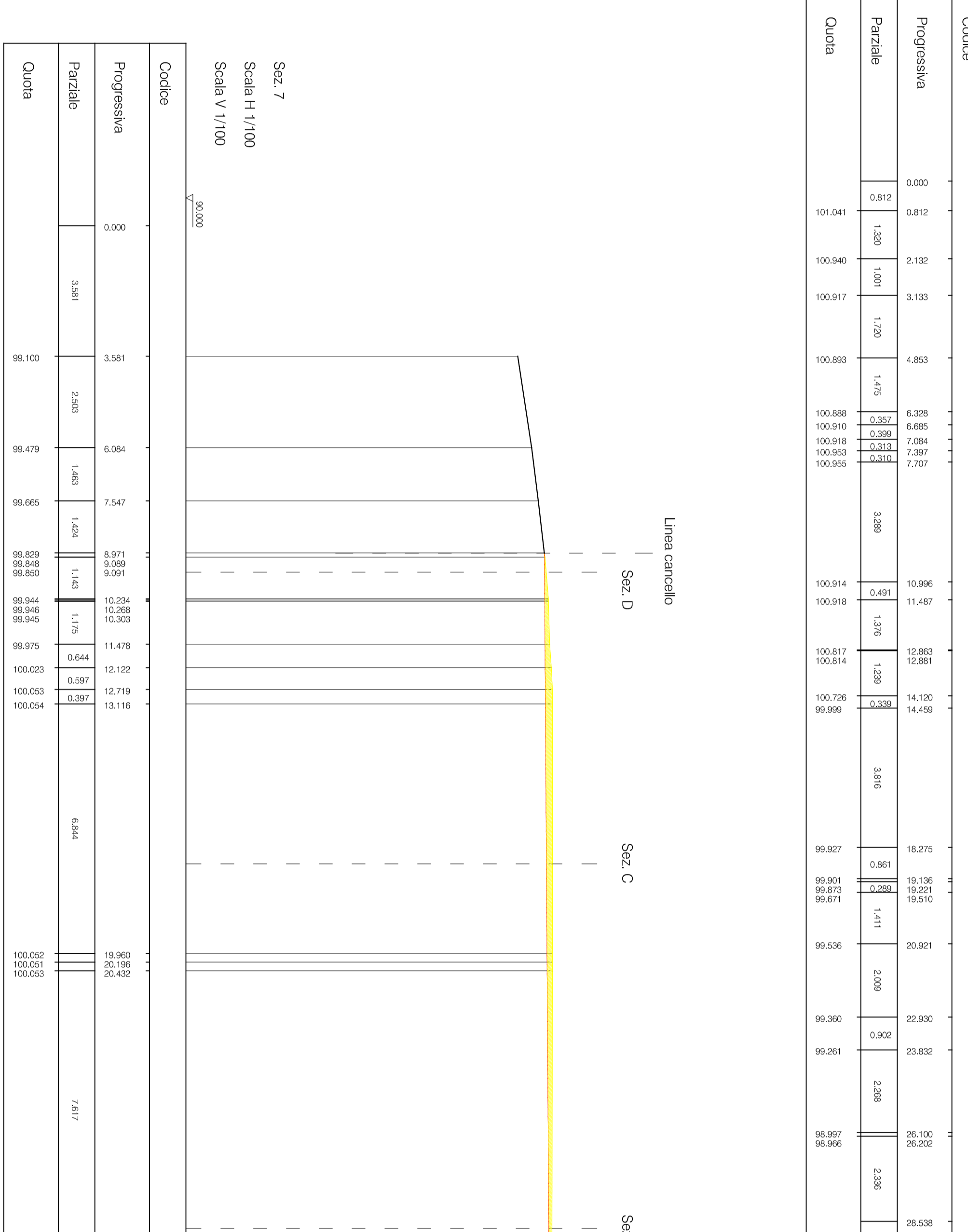
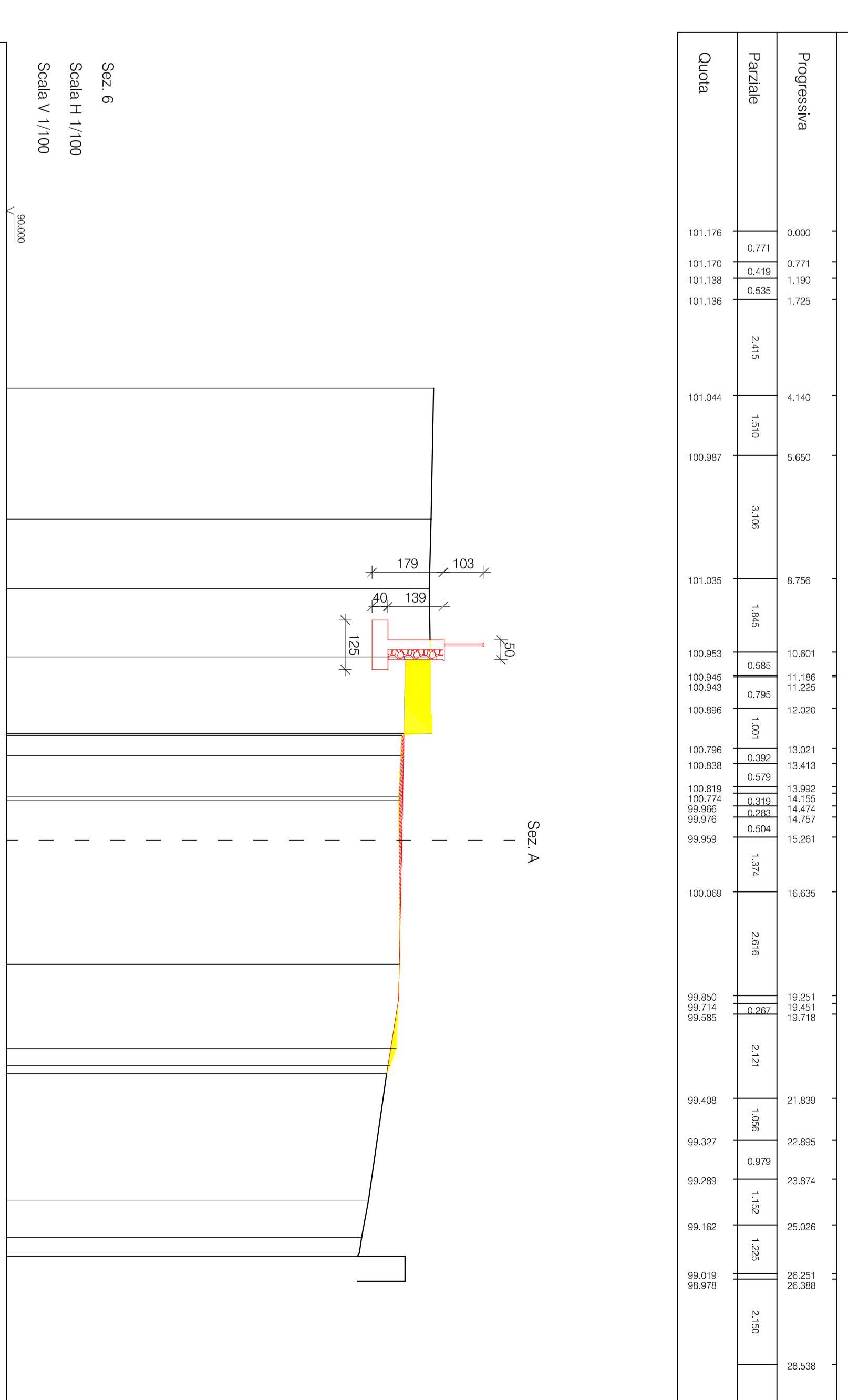
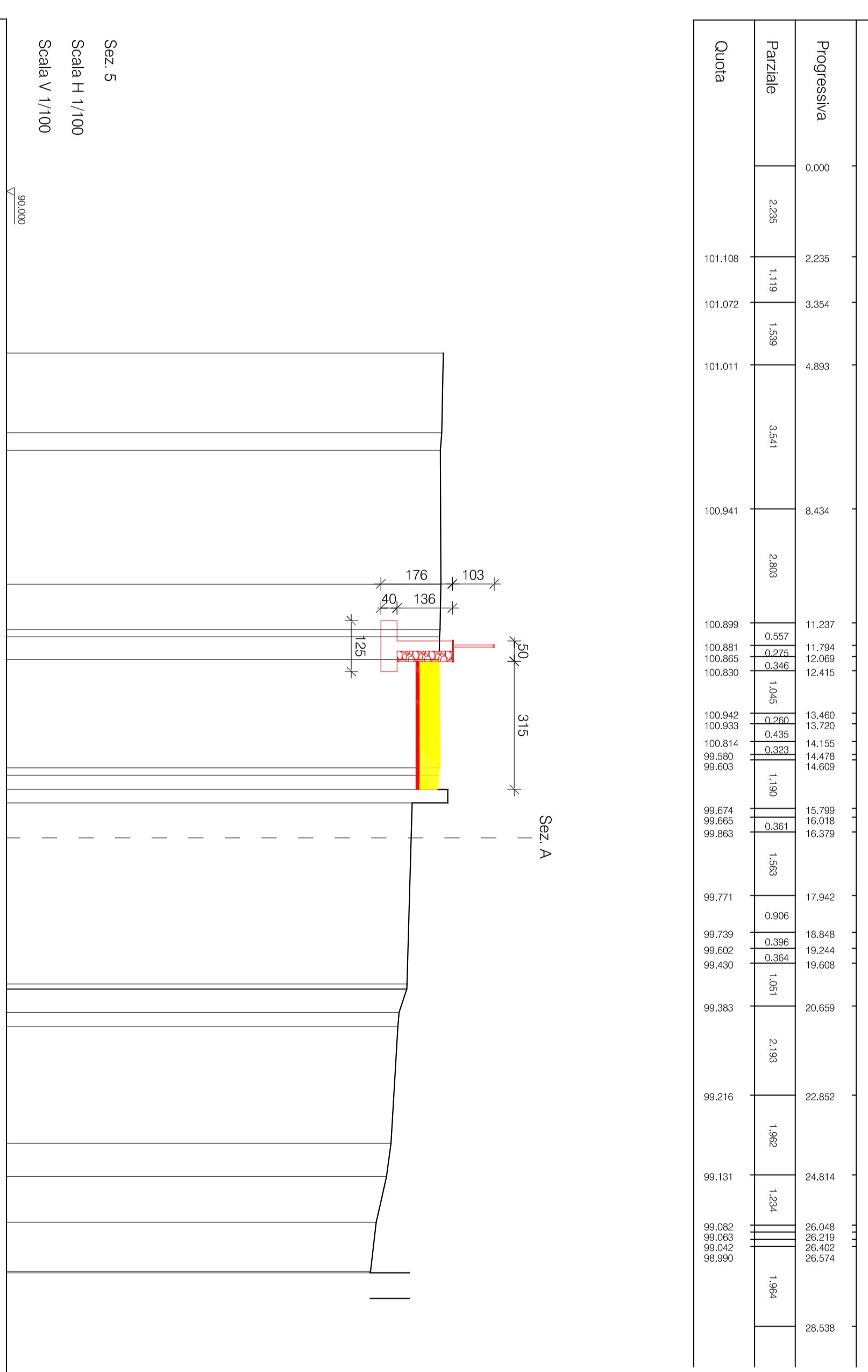
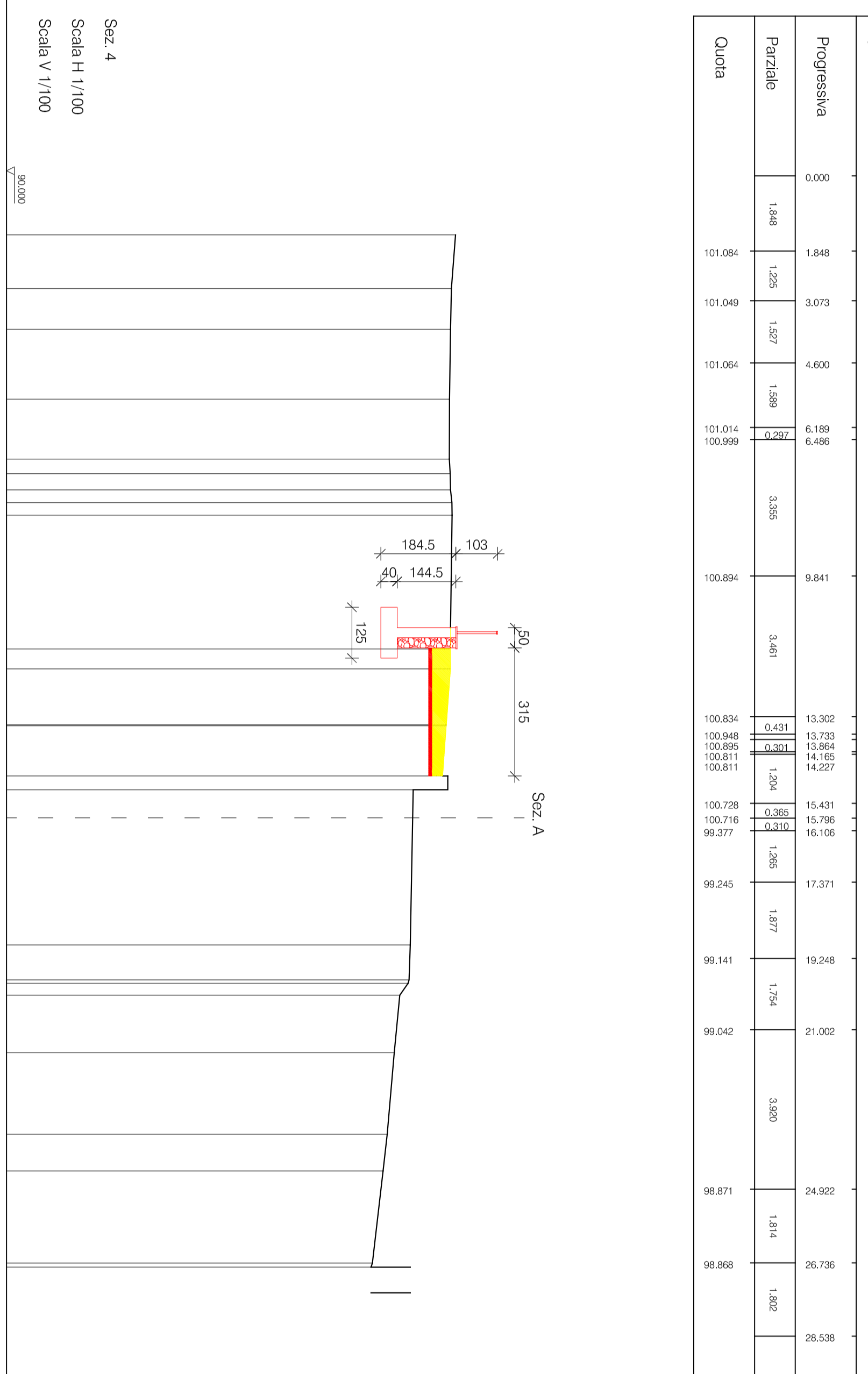
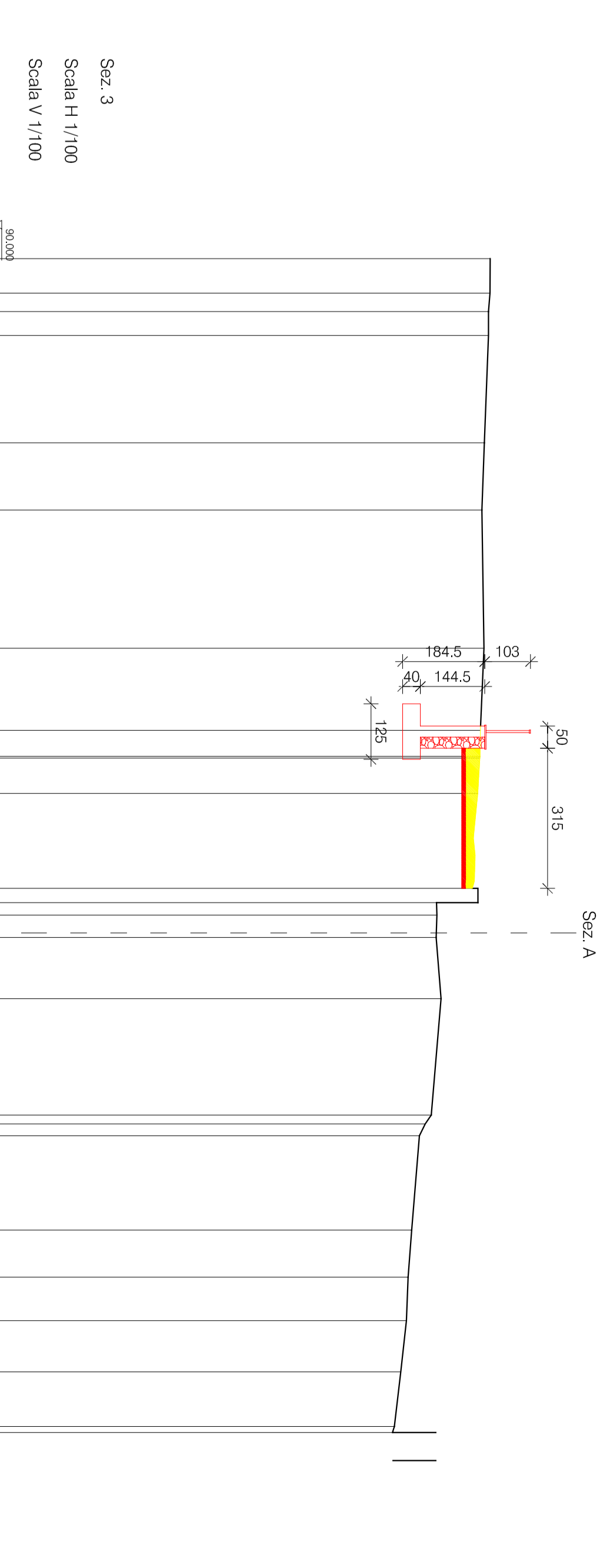
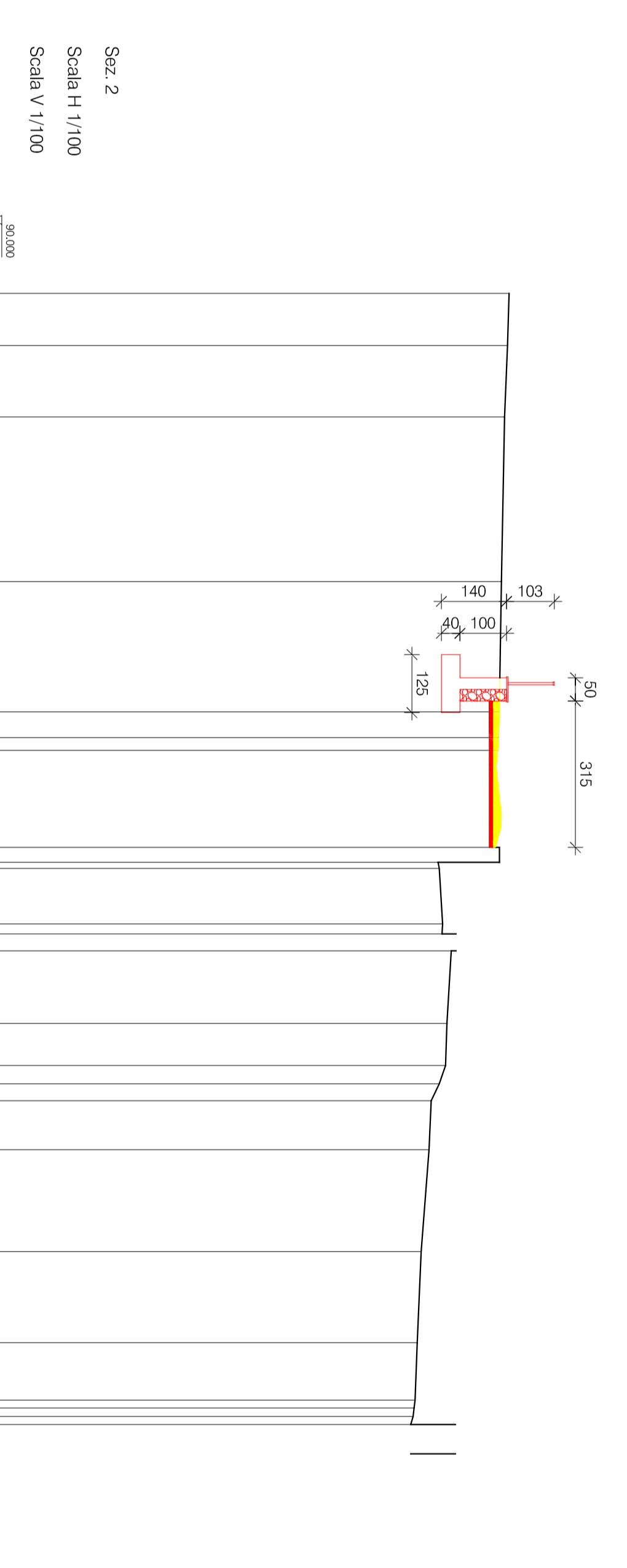
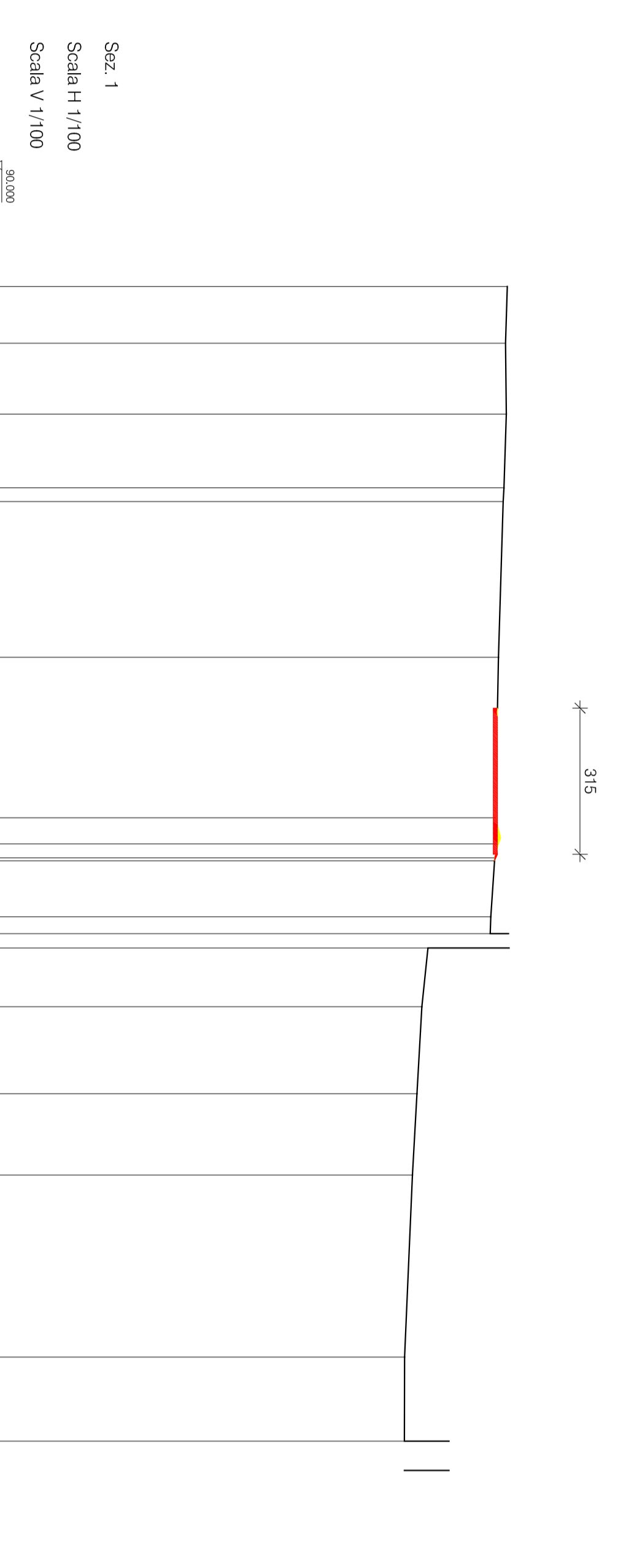

Sez. B
Scala H/1100
Scala V/1100

Progressiva	Partiale	Quota
0.00	0.00	99.26
1.00	2.00	99.10
2.00	4.00	99.01
3.00	6.00	99.01
4.00	8.00	99.01
5.00	10.00	99.01
6.00	12.00	99.01
7.00	14.00	99.01
8.00	16.00	99.01
9.00	18.00	99.01
10.00	20.00	99.01
11.00	22.00	99.01
12.00	24.00	99.01
13.00	26.00	99.01
14.00	28.00	99.01
15.00	30.00	99.01
16.00	32.00	99.01
17.00	34.00	99.01
18.00	36.00	99.01
19.00	38.00	99.01
20.00	40.00	99.01
21.00	42.00	99.01
22.00	44.00	99.01
23.00	46.00	99.01
24.00	48.00	99.01
25.00	50.00	99.01
26.00	52.00	99.01
27.00	54.00	99.01
28.00	56.00	99.01
29.00	58.00	99.01
30.00	60.00	99.01
31.00	62.00	99.01
32.00	64.00	99.01
33.00	66.00	99.01
34.00	68.00	99.01
35.00	70.00	99.01
36.00	72.00	99.01
37.00	74.00	99.01
38.00	76.00	99.01
39.00	78.00	99.01
40.00	80.00	99.01
41.00	82.00	99.01
42.00	84.00	99.01
43.00	86.00	99.01
44.00	88.00	99.01
45.00	90.00	99.01
46.00	92.00	99.01
47.00	94.00	99.01
48.00	96.00	99.01
49.00	98.00	99.01
50.00	100.00	99.01

Sez. C
Scala H/1100
Scala V/1100

Progressiva	Partiale	Quota
0.00	0.00	99.26
1.00	2.00	99.10
2.00	4.00	99.01
3.00	6.00	99.01
4.00	8.00	99.01
5.00	10.00	99.01
6.00	12.00	99.01
7.00	14.00	99.01
8.00	16.00	99.01
9.00	18.00	99.01
10.00	20.00	99.01
11.00	22.00	99.01
12.00	24.00	99.01
13.00	26.00	99.01
14.00	28.00	99.01
15.00	30.00	99.01
16.00	32.00	99.01
17.00	34.00	99.01
18.00	36.00	99.01
19.00	38.00	99.01
20.00	40.00	99.01
21.00	42.00	99.01
22.00	44.00	99.01
23.00	46.00	99.01
24.00	48.00	99.01
25.00	50.00	99.01
26.00	52.00	99.01
27.00	54.00	99.01
28.00	56.00	99.01
29.00	58.00	99.01
30.00	60.00	99.01
31.00	62.00	99.01
32.00	64.00	99.01
33.00	66.00	99.01
34.00	68.00	99.01
35.00	70.00	99.01
36.00	72.00	99.01
37.00	74.00	99.01
38.00	76.00	99.01
39.00	78.00	99.01
40.00	80.00	99.01
41.00	82.00	99.01
42.00	84.00	99.01
43.00	86.00	99.01
44.00	88.00	99.01
45.00	90.00	99.01
46.00	92.00	99.01
47.00	94.00	99.01
48.00	96.00	99.01
49.00	98.00	99.01
50.00	100.00	99.01

Sez. D
Scala H/1100
Scala V/1100

Progressiva	Partiale	Quota
0.00	0.00	99.26
1.00	2.00	99.10
2.00	4.00	99.01
3.00	6.00	99.01
4.00	8.00	99.01
5.00	10.00	99.01
6.00	12.00	99.01
7.00	14.00	99.01
8.00	16.00	99.01
9.00	18.00	99.01
10.00	20.00	99.01
11.00	22.00	99.01
12.00	24.00	99.01
13.00	26.00	99.01
14.00	28.00	99.01
15.00	30.00	99.01
16.00	32.00	99.01
17.00	34.00	99.01
18.00	36.00	99.01
19.00	38.00	99.01
20.00	40.00	99.01
21.00	42.00	99.01
22.00	44.00	99.01
23.00	46.00	99.01
24.00	48.00	99.01
25.00	50.00	99.01
26.00	52.00	99.01
27.00	54.00	99.01
28.00	56.00	99.01
29.00	58.00	99.01
30.00	60.00	99.01
31.00	62.00	99.01
32.00	64.00	99.01
33.00	66.00	99.01
34.00	68.00	99.01
35.00	70.00	99.01
36.00	72.00	99.01
37.00	74.00	99.01
38.00	76.00	99.01
39.00	78.00	99.01
40.00	80.00	99.01
41.00	82.00	99.01
42.00	84.00	99.01
43.00	86.00	99.01
44.00	88.00	99.01
45.00	90.00	99.01
46.00	92.00	99.01
47.00	94.00	99.01
48.00	96.00	99.01
49.00	98.00	99.01
50.00	100.00	99.01

